



NADIR

RIFLETTORI INDUSTRIALI - HIGH BAYS - REFLECTEURS INDUSTRIELS



ARCLUCE

Arcluce S.p.A.

Via 1° Maggio, 6

20070 San Zenone al Lambro, Milano, Italia

Tel. +39 02 9810981 - Fax +39 02 98264062



I AVVERTENZE:

SONO VIETATE MODIFICHE ALL'APPARECCHIO SENZA NOSTRA AUTORIZZAZIONE

- La sicurezza e il corretto funzionamento dell'apparecchio sono garantiti solo rispettando le normative elettriche e queste istruzioni; pertanto è necessario conservarle.
- L'installazione deve essere eseguita da personale qualificato.
- Non utilizzare lampade di tipo diverso o di potenza superiore rispetto a quelle indicate.
- Utilizzare solo ricambi originali ARCLUCE.

Direttiva 2002/96/CE (Rifiuti di Apparecchiature Elettriche ed Elettroniche - RAEE)
 L'etichetta con il cassonetto barrato indica che il prodotto non deve essere smaltito come un normale rifiuto urbano, ma attraverso una raccolta separata; questo al fine di evitare potenziali conseguenze negative per l'ambiente e per la salute umana. Per maggiori dettagli sui centri di raccolta disponibili contattare l'ufficio governativo locale o il rivenditore di prodotto.

- In caso di manutenzione togliere la tensione.
- Distanza minima dagli oggetti illuminati (metri).
- Gruppo di rischio 1 (EN 62471). Non fissare il LED durante il suo funzionamento.

Queste istruzioni e altra documentazione tecnica continuamente aggiornata è disponibile sul sito www.arcluce.it.

ENG WARNING:

ANY MODIFICATION TO THIS FITTING IS FORBIDDEN WITHOUT OUR AUTHORIZATION

- The safety and the proper functioning of the fitting is guaranteed only respecting the electrical Standards and this mounting instructions; so it's necessary to keep them.
- Installation should be carried out by a suitable qualified person.
- Do not use different type or higher power lamps than indicated.
- Only use original ARCLUCE spare parts.

Directive 2002/96/CE (Waste Electrical and Electronic Equipment - WEEE)
 The crossed out wheeled bin label that this product should not be disposed how the normal household waste stream, but with a separate collection; this in order to prevent potential negative consequences for the environment and the human health. For more details on available collection facilities please contact your local government office or the dealer where you purchased this product.

- Turn power off before maintenance.
- Minimum distance from lighted objects (metres).
- Risk group 1 (EN 62471). Do not stare at operating LED.

This data sheet and other technical documents continually updated can be accessed at www.arcluce.it.

FR AVERTISSEMENT:

TOUTE MODIFICATION DE CET APPAREIL, SANS NOTRE AUTORISATION, EST INTERDITE

- La sécurité et le fonctionnement correct de l'appareil sont garantis respectant les normes électriques et ces instructions; il est donc nécessaire de les conserver.
- L'installation doit être faite par personnel qualifié.
- Ne pas utiliser de lampes différentes pour typologie ou puissance de celles indiquées.
- Utiliser seulement pièces de rechange originales ARCLUCE.

Directive 2002/96/CE (Déchets d'Equipements Electriques et Electroniques - DEEE)
 L'étiquette avec la case cochée indique que le produit ne doit pas être traité comme déchet ménager, mais à travers une collecte sélective; cette afin d'éviter d'éventuels dommages au niveau de l'environnement ou de la vie humaine. Pour plus de détails sur les sites de collecte existants, veuillez contacter l'administration local ou le détaillant auprès duquel vous avez acheté ce produit.

- Avant toute intervention sur l'appareil fermer le courant.
- Distance minimale des objets à éclairer (mètre).
- Groupe à risque 1 (EN 62471). Ne pas regarder le LEDs quand elle est allumée.

Cette fiche d'instructions et d'autre documentation technique constamment mise à jour sont disponibles sur notre web-site www.arcluce.it.

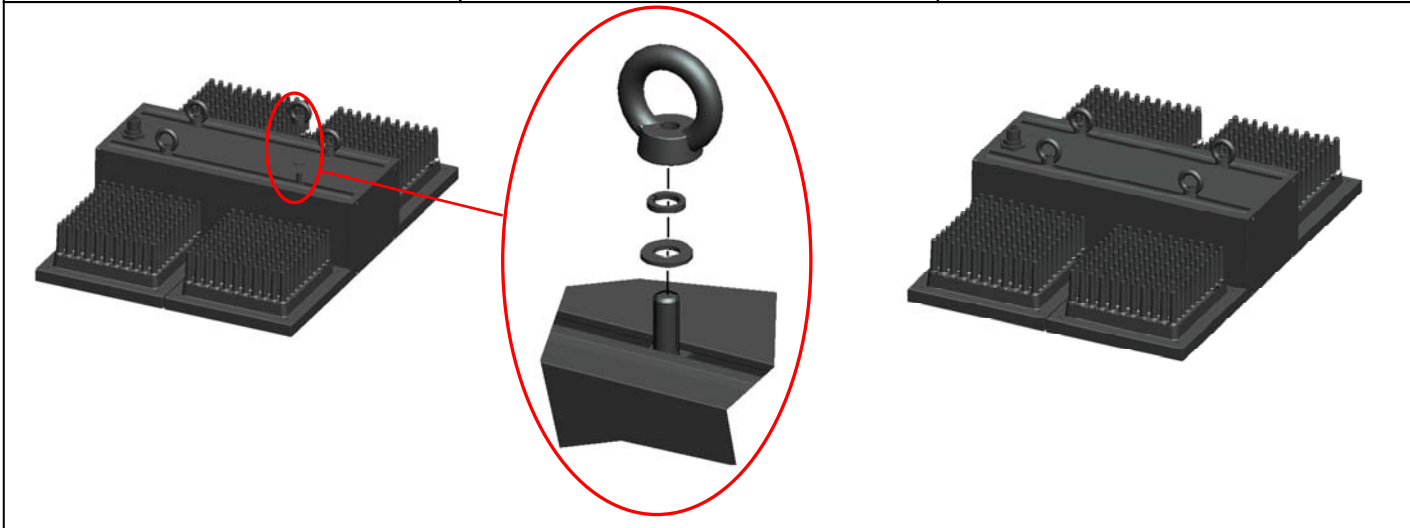
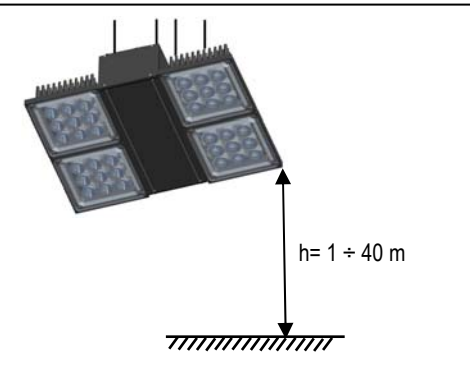
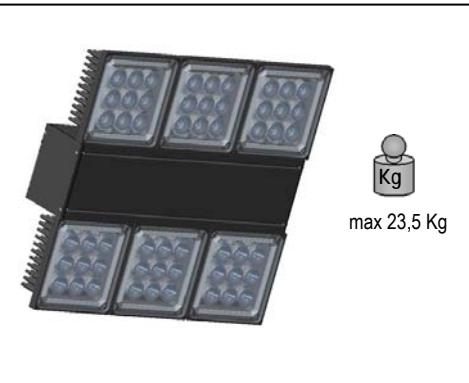
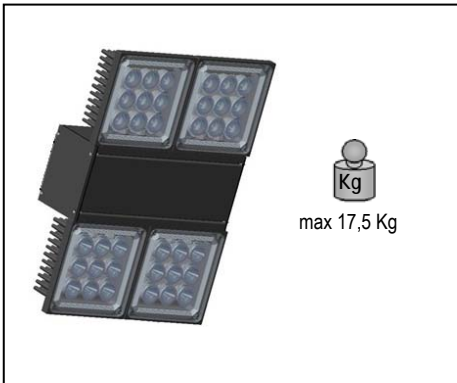



NADIR

RIFLETTORI INDUSTRIALI - HIGH BAYS - REFLECTEURS INDUSTRIELS

SPINA DI CONNESSIONE IP66
IP66 CONNECTION PLUG
FICHE DE CONNEXION IP66

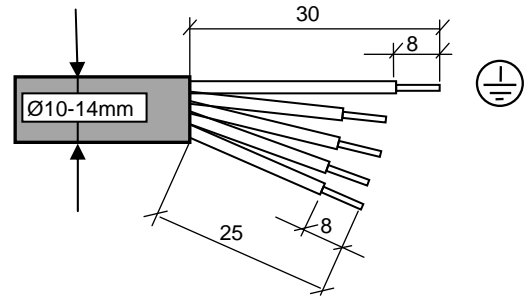
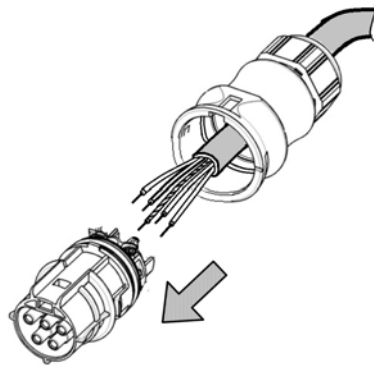

CEI

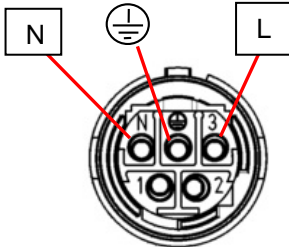

DIMM 1-10V

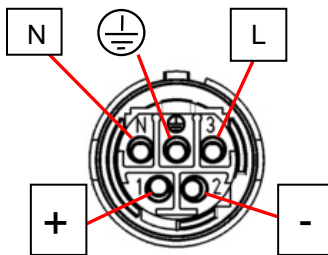

DALI

